

PSC-X22 STANDARD

Slip Rings can be used in any system requiring the transmission of electrical and/or power signals to an intermittently or continuously rotating shaft. Thanks to the small ring diameter, the PSC X Series, grants low peripheral speed between brushes and rings, as well as reduced dynamic imbalance what means very low wear. Moreover, the use of noble metals (gold to gold alloy) assures long lasting using life, reduced electric noise and interferences among circuits, low contact electric resistance.

The above features make the PSC X Series specially suited to transmission of critical signals, such as hi frequency signals (video, field buses, etc.), very low currents and voltages (strain gages, thermocouples, measuring equipment etc.), even versions with 2A circuits are available. For higher than 2A please contact us.

Conceived to deliver a flexible, cost-effective, reliable and hi-quality solution, These units are available in many standard configurations and with 6 to 36 circuits. Their compact size allows installation into small systems thus requiring high performances.

TECHNICAL SPECIFICATION

Number Of Circuits	6-36 Circuits
Rated Voltage	240VDC/240VAC
Cable Size	AWG26, color coded, FEP insulated, silver plated copper.
Cable Length	250mm. Standard (other lengths on demand)
Dielectric Strength	500VAC@50Hz 60s
Insulation Resistance	1000MΩ/500VDC
Noise	< 0.01Ω
Operating Speed	0~300rpm (For higher speed please contact us)
Temperature	-20°C to +80°C (option: -40 to +80°C on AL housing)
Contact	Precious Metals
Protection	IP51 or higher on request

PRODUCT FEATURES

- Quick Delivery
- Low Cost
- Ideal For Video & Digital Signals
- Gold Alloy Rings & Brushes
- High Reliability
- Low Friction Torque
- Smooth Rotation
- In Compliance With Ce & Rohs Standards

APPLICATIONS

- Video Systems
- Robotics
- Hose & Cable Reels
- Medical / Pharmaceutical
- Wind Turbines (small)
- Packaging

STANDARD MODEL PSC-X22

OUTLINE DIMENSIONS

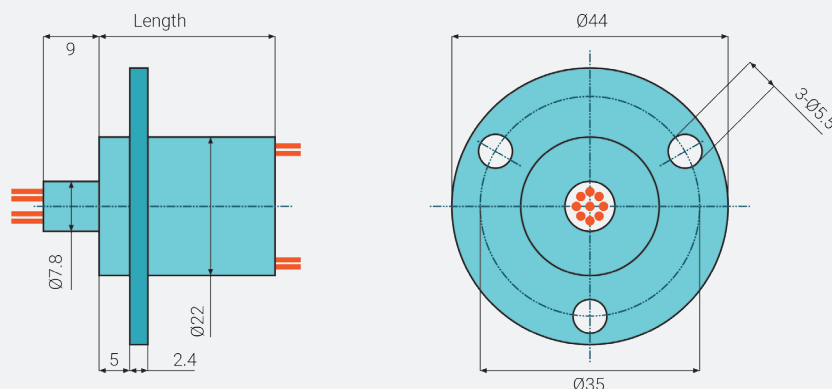

Model	Length
PSC-X22-6	19 mm
PSC-X22-12	28 mm
PSC-X22-15	29.5 mm
PSC-X22-18	33.4 mm
PSC-X22-24	41.2 mm
PSC-X22-36	56.8 mm

Model	No. Of Circuits		Possible modification		Length	Housing
	Total	Signals	Power			
		1-2A	6A	10A		
PSC-X22-6	6	6	-	-	19 mm	ABS
PSC-X22-7	7	7	-	-	19 mm	ABS
PSC-X22-12	12	12	-	-	28 mm	ABS
PSC-X22-12-2P/2S	4	2	2	-	28 mm	ABS
PSC-X22-15	15	15	-	-	29.5 mm	ABS
PSC-X22-18	18	18	-	-	33.4 mm	ABS
PSC-X22-18-3P	3	-	-	3	33.4 mm	ABS
PSC-X22-24	24	24	-	-	41.2 mm	ABS
PSC-X22-24-4P/6S	10	6	4	-	41.2 mm	ABS
PSC-X22-36	36	36	-	-	56.8 mm	ABS

MODIFY ACCORDING TO YOUR NEEDS

Our standard range of slip ring can be modified to suit your applications requirement. It is possible to modify the current capacity and signal type through the slip ring, or integrate the electrical slip ring with optical or fluid rotary joint, or why not integrate the slip ring with an angle transducer, or modify the slip ring with mechanical flanges and connectors.

Through modifying our standard slip rings, we can offer a solution that suit your application and fulfils your requirement.

Get in touch with us today to learn more about possibilities, as they are endless. We work hard to bring you the very best and quality that will last.

CABLES

- Twisted Cables
- Colour Coded
- Rg Cable For Video

FLANGE

- Different Mounting
- Slip Ring Inside Flange
- Encoder Shaft Through

TRANSFER

- EtherCAT
- Profinet
- Powerlink
- Can Bus
- Gigabit Ethernet

HOUSING

- IP-rating of 51 or Higher on request.
- Plastic
- Aluminium
- Stainless steel

MODEL PSC-X22A

OUTLINE DIMENSIONS

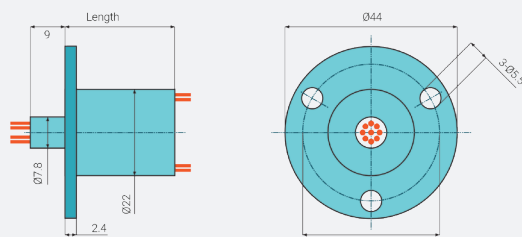

Model	Length
PSC-X22A-6	19 mm
PSC-X22A-12	28 mm

MODEL PSC-X22A1-18

OUTLINE DIMENSIONS

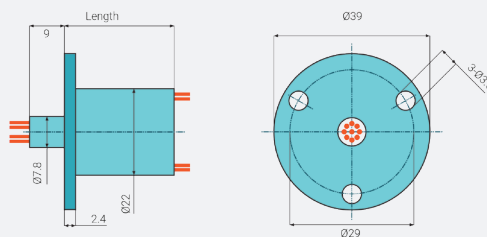

Model	Length
PSC-X22A1-18	33.4 mm

MODEL PSC-X22B

OUTLINE DIMENSIONS

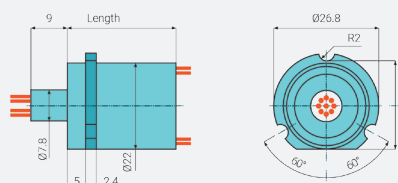

Model	Length
PSC-X22B-6	19 mm
PSC-X22B-12	28 mm
PSC-X22B-18	33.4 mm
PSC-X22B-24	41.2 mm

MODEL PSC-X22C

OUTLINE DIMENSIONS

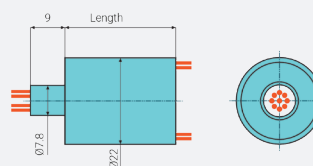

Model	Length
PSC-X22C-6	19 mm
PSC-X22C-12	28 mm
PSC-X22C-18	33.4 mm
PSC-X22C-24	41.2 mm

MODEL PSC-X22C1

OUTLINE DIMENSIONS

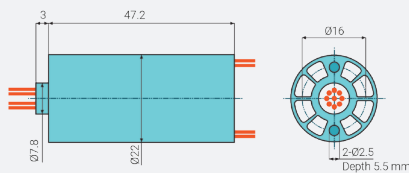

Model	Length
PSC-X22C1-24	47.2 mm

MODEL PSC-X22D

OUTLINE DIMENSIONS

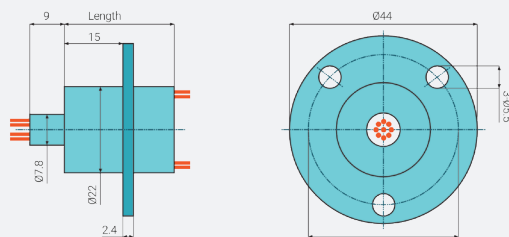

Model	Length
PSC-X22D-12	28 mm

MODEL PSC-X122D1

OUTLINE DIMENSIONS

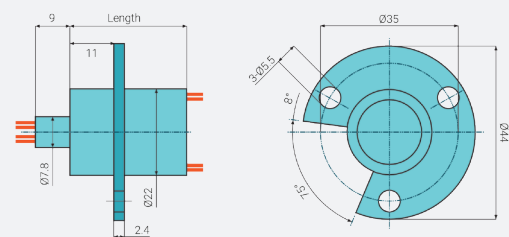

Model	Length
PSC-X22D1-12	28 mm
PSC-X22D1-15	29.5 mm
PSC-X22D1-18	33.4 mm

MODEL PSC-X22D2

OUTLINE DIMENSIONS

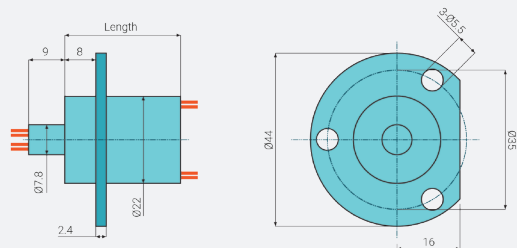

Model	Length
PSC-X22D2-15	29.5 mm

MODEL PSC-X22D3

OUTLINE DIMENSIONS

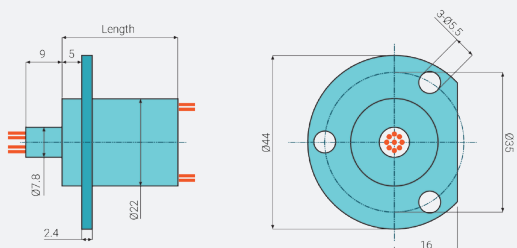

Model	Length
PSC-X22D3-12	28 mm

MODEL PSC-X22F

OUTLINE DIMENSIONS

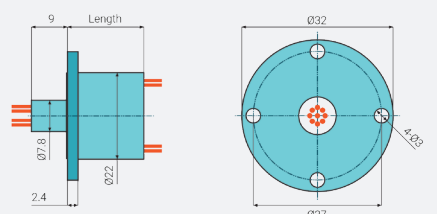

Model	Length
PSC-X22F-6	19 mm
PSC-X22F-24	33.4 mm

PSC LEAD COLOURS

Standard Colour Codes

PSC SERIES

Standard Colour Codes						
PSC-X	1.RED	2.YELLOW	3.BLACK	4.BLUE	5.GREEN	6.WHITE
	7.PURPLE	8.GREY	9.BROWN	10.ORANGE	11.DEEP BLUE	12.KHAKI
	13.WHITE/RED	14.WHITE/BLACK	15.WHITE/BLUE	16.WHITE /PURPLE	17.WHITE/BROWN	18.WHITE/GREEN
	19.WHITE/ORANGE	20.WHITE/YELLOW	21.WHITE/GREY	22.BLACK/RED	23.BLACK/BLUE	24.YELLOW/GREEN
	<i>For slip rings with more than 24 circuits, the colours is repeated, and placed in separate identified shrink tubes. Labels can be added on request.</i>					

DISCLAIMER

Colour can mismatch depending on configuration and cable type. The colours listed in the table above are standard colour codes, this means that they can change on different models and housing. Please contact Penlink with your PSC model for correct colour coding.

SIGNALS & BUS

Our standard slip rings comes with signals for data, video and power transmission. Your transmission requirements are key when picking out the right product. Knowing the transmission will enable us to find the right slip ring for your project.

If you can't find a model with the right transmission we can always modify the slip ring for you. This may alter the design of the slip ring so always get in touch with us for more information regarding your model and specification.

DATA CIRCUITS

Our slip ring handle up to 1 GB of data (1000Base-X), and can be equipped with different cable to be used for all known industry standard data, as example, Profinet, Can-bus, Profibus, DMX, 100Base-X or similar type. It's even possible to transfer several independent data channels through one slip ring.

VIDEO SIGNALS

Our slip ring handle both standard and high definition videos, up to SMPTE 424M/2,97 gb/s with 3G HD-SDI. Combined with our optical joint, the slip ring handle up to 24G-SDI.

POWER CIRCUITS

For the compact PSC Series, 2A rings are default, but it can be combined up to 16A depending on your needs and the slip ring configurations. Please contact us for help to specify your slip ring!

